

FOREST

DRAPERY HARDWARE



CKS[®]
Corded Klick System

CKS[®] Corded Klick System

Product information

- Highly efficient cord traversing system with separate internal cord channels; preventing cord sag and eliminating cord tangle.
- Quick installation with "Smart Klick" brackets for wall and ceiling applications.
- Bendable; it can be curved and reverse curved by using a 10 cm (4") radius or continuous curved.
- Heavy duty clickable carriers -UV protected - for smooth and easy traversing. Offset shape for straight hanging pleats.
- Can also be used for ripplefold or accordiafold drapery systems.
- Maximum fabric weight: ± 6 kg per meter (4,5 LBS per ft.).
- Colours available: white and silver.
- Available lengths: 4 meter (13'1"), 5 meter (16'4"), 6 meter (19'8").
- Track finish: chromated powder coated with a factory applied patented dry lubricant.
- Limited lifetime warranty.

For use in

Hotels - offices - residences - boats - campers - planes or any location where an efficient cord traversing system is required.

Applications

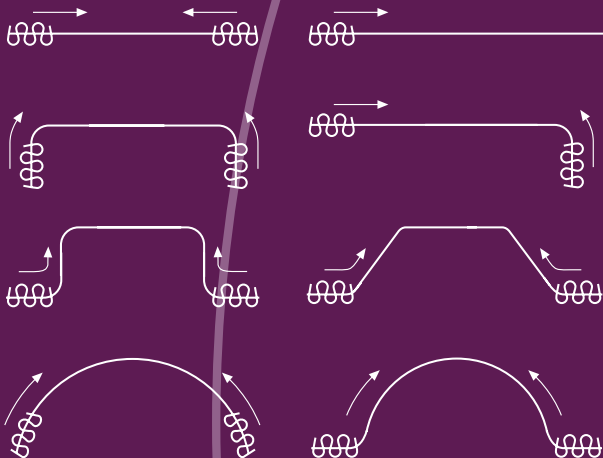

Bending and assembly instructions available on request

Bending/ curving

The track can be curved and reverse curved using a 10 cm (4") radius. Continuous curving can easily be done using the continuous curver or the electric powered bender.

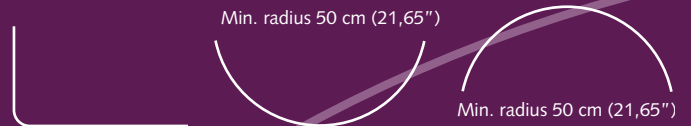

Profile

- Shown actual size 1:1
- Aluminium Extrusion
- Weight: 202 grams per meter (2.17 ounce per ft.)
- Dimensions: 14 mm x 20 mm (0,6" x 0,8").

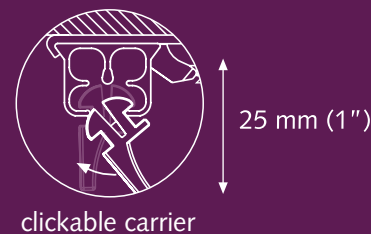
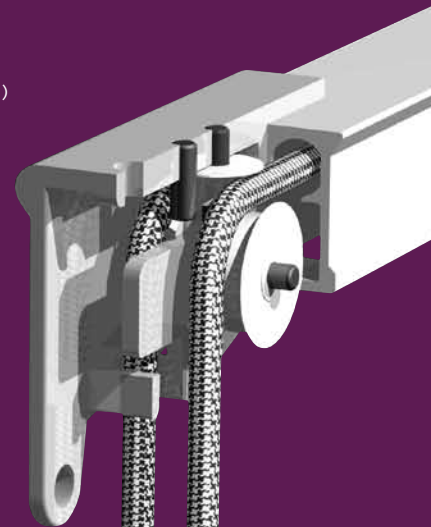
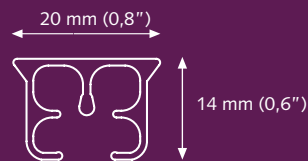

- ① CKS Track
- ② KS Carrier
- ③ CKS Master Carrier Overlap
- ④ CKS Master Carrier Underlap
- ⑤ CKS Pulley

Mounting Brackets

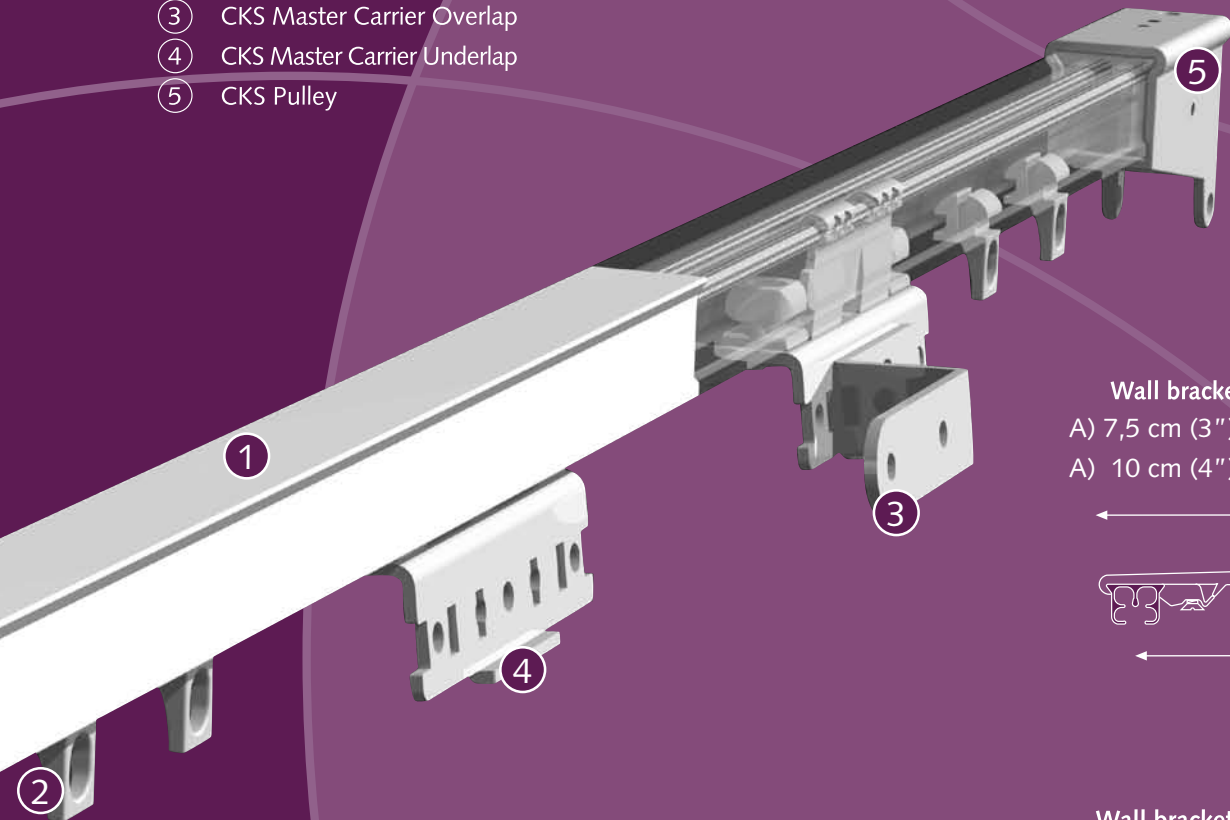

Ceiling Bracket

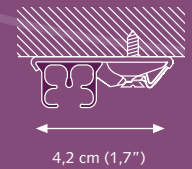

Wall bracket aluminium single
 A) 7,5 cm (3''), B) 6,3 cm (2,5'')
 A) 10 cm (4''), B) 8,8 cm (3,5'')

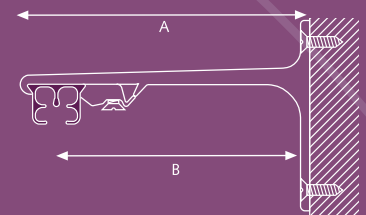

Wall bracket aluminium double
 A) 15 cm (6''), B) 9,2 cm (3,6''), C) 4,5 cm (1,8'')
 A) 20 cm (8''), B) 9,2 cm (3,6''), C) 9,5 cm (3,7'')

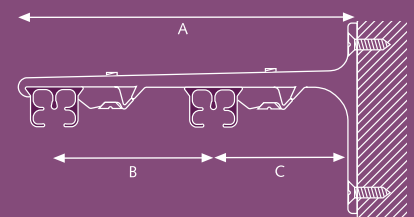

Wall bracket

3,5 cm (1,4''), 6 cm (2,4'')

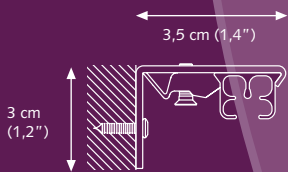

A) Min. 10 cm (4'')



A) Min. 15 cm (6'')



Wall bracket aluminium triple

25 cm (10'')

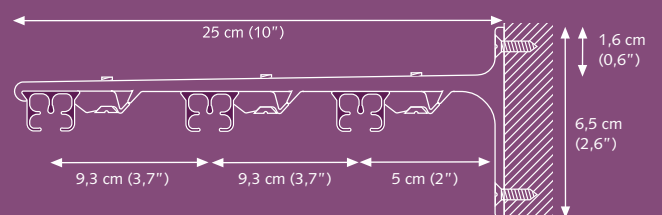

Other brackets are available. Brackets need to be placed every 60 cm (24'').

Colours available from stock:

Complete the art.nr. with the indicated colour-code

01 White**03 Silver**

Other colours can be delivered on request.

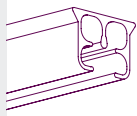

CKS Track 15010..00 cm
20/bundle
Aluminium extrusion, powder coated, lubricated. Colours 01, 03. Available lengths: 4 m. (13'1"), 5 m. (16'4"), 6 m. (19'8"). Silver only in 5 meter length



Carrier 10100..000
500/box
"Klickable", offset, constructed of UV resistant plastic. 10 Carriers on a break-away strip. Can be clicked in after installation.



CKS Master Carrier Overlap 15157..000
25/box
Will go through curves.



CKS Master Carrier Underlap 15156..000
25/box
Will go through curves.

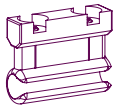

CKS Cord Connector 1530301000
100/box
Connects cord to the CKS Master Carrier. Colours: 01

CKS Cord Connector Half 1530311000
100/box
Connects cord to the CKS Master Carrier. Colours: 01

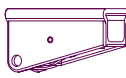

CKS Pulley 15301..000
25/box
Reversible, for two way draw.

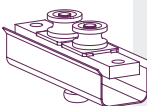

CKS Center Pulley 1530101020
25/box
to join two equal sized tracks in the middle, to create lengths > 6 meter. (19' 18")

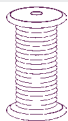

Traverse Cord 1030401000
250 mtr/roll
Nylon drapery cord designed for strong smooth slide, Ø 3.5 mm (0,14") 16 ply. White



CKS End Pulley White Short 1530101011
25/box
Especially for one-way closing of the curtain.



Tension Pulley 1030501000
25/box
Plastic, white.



Cord Weight 3030601000
25/box
Plastic, available in white only

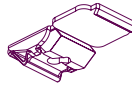

Smart Klick Ceiling Bracket 10182..000
100/box
"Klicks" onto track, powder coated. Install with counter sunk head screw 4 mm.

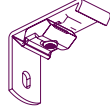

Smart Klick Wall Bracket 50/box
3,5 cm (1³/₈") and 6 cm (2³/₈"). "Klicks" onto track, powder coated. One screw attachment.

For light weight use only. 10202..060

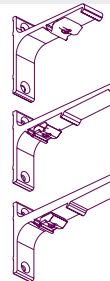

Aluminium Wall bracket 10203..000mm
Smart klick, powder coated.

7,5 cm single (3") 20/box

10 cm single (4") 20/box

15 cm double (6") 15/box

20 cm double (8") 15/box

25 cm triple (10") 10/box

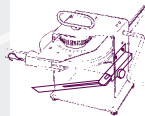

Compact Bending Tool 105000000
1/box
For 20 mm (0,8") KS/CRS

KS/CKS Bending Wheel All-in 105100000
1/box
For 20 mm (0,8") KS/CRS incl. strips

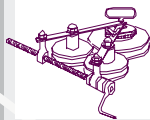

Continuous Curver 1060200000
1/box
Add on tool for the Compact Bending tool. Designed to create continuous curves and arches in any radius. Includes bending strip. For CKS/KS track only.

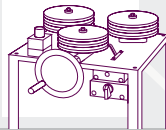

Electric Powered Bender 1060500000
1/box
Available in 230V or 115V, to create continuous curves and arches. Minimum radius 50 cm (20").

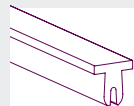

CKS Replacement Bending Strip 1560100000
1/each
For Compact Bending Tool. Length of strip: 60 cm (23")

For Continues Curver / electric bender. Length of strip: 7 mtr. (23") 1560300000
1/each



KS/CKS Bending Wheels 1060700000
1/set
For electric powered bender. Complete set of 3 wheels. For CKS/KS track only.

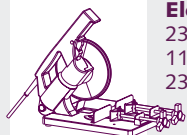

Electric Powered Railcutter 1/each
230 Volt EU 1061100000
115 Volt USA 1061200001
230 Volt UK 1061200002

Replacement blade 1061200000
1/each
For electric powered railcutter.

Distributor:

FOREST

DRAPERY HARDWARE