

# FOREST<sup>®</sup>

DRAPERY HARDWARE



**DS<sup>®</sup>**  
*Design System*

## Product information

- Elegant and aesthetically pleasing hand drawn system for all types of medium weight draperies.
- Quick installation with "Smart Klick" brackets for wall and ceiling applications.
- Bendable; it can be curved for outside bends only using a 10 cm (4") radius or continuous curved.
- Hidden brackets through elegant shape of the track.
- Same brackets as used with KS system.
- Heavy duty clickable carriers - UV protected - for smooth and easy traversing. Offset shape for straight hanging pleats.
- Can also be used for ripplefold and accordiafold drapery systems.
- Maximum fabric weight: 8 kg per meter (6 LBS per ft.).
- Colours available: white, silver and black.
- Special colours: available on request.
- Available lengths: 4 meter (13'1"), 5 meter (16'4"), 6 meter (19'8"). Silver and black only in 5 meter length.
- Track finish: chromated powder coating with a factory applied patented dry lubricant.
- Limited lifetime warranty.

## Applications

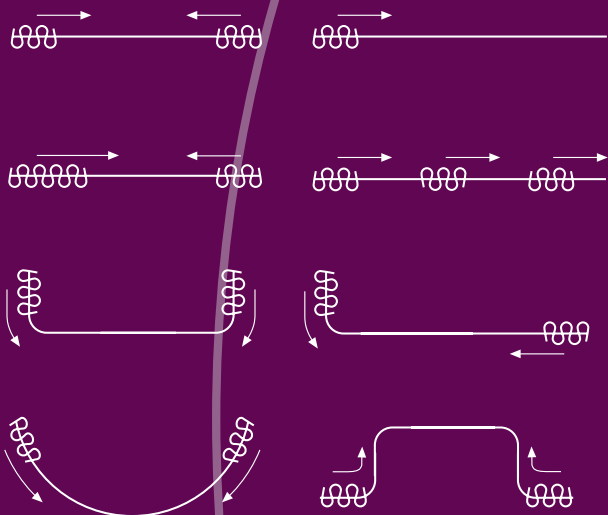

## For use in

Hotels - offices - schools - healthcare - residences - boats - campers - planes or at any location where an elegant efficient hand drawn system is required.

## Profile

- Shown actual size 1:1.
- Aluminum Extrusion.
- Weight: 170 grams per meter (1.83 ounce per ft.).
- Dimensions: 11 mm x 24 mm (0,4" x 0,9").

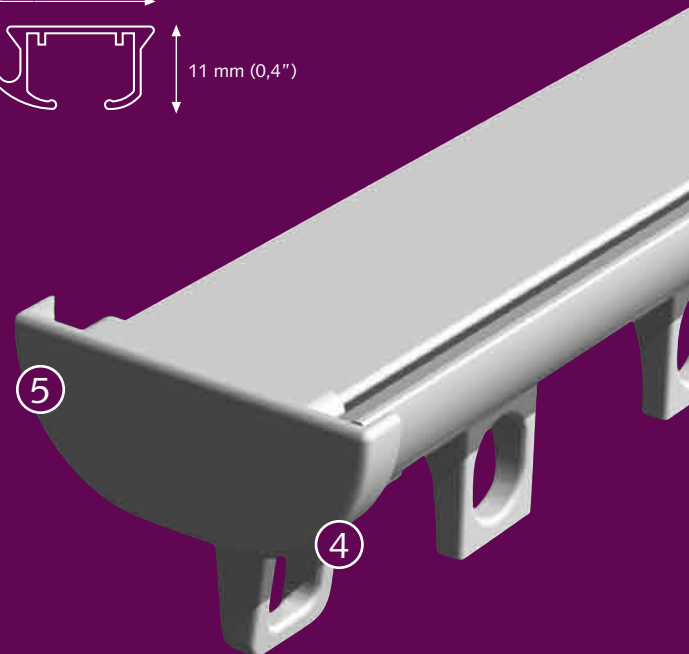
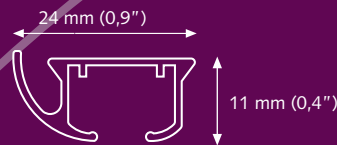

## Bending/ curving

The track can be curved for outside bends by using a 10 cm (4") radius. Continuous curving is available by special order from factory only.



- ① DS track
- ② Carrier
- ③ Stop carrier
- ④ End stop
- ⑤ End cap

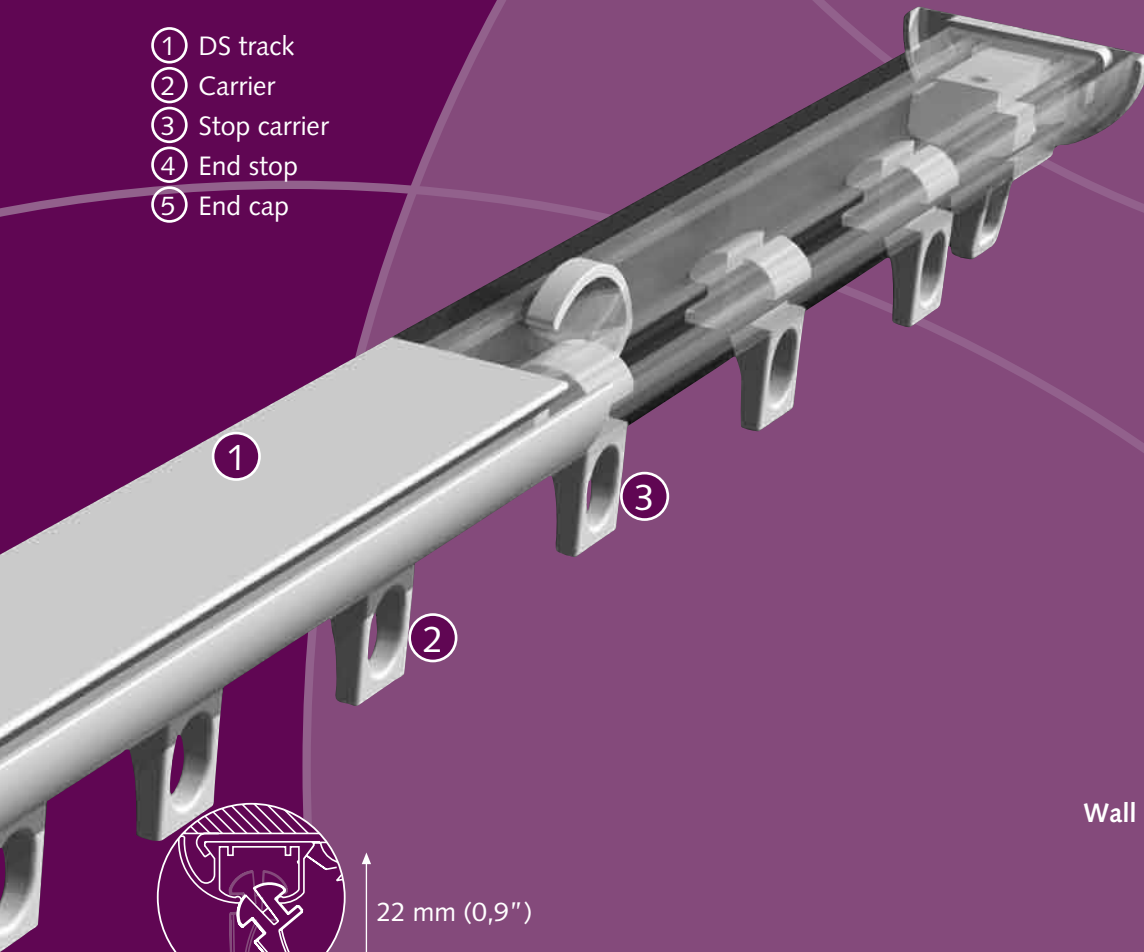

## Mounting Brackets

### Ceiling Bracket



4,2 cm (1,7")

### Wall bracket

3,5 cm (1,4")  
6 cm (2,4")

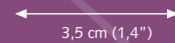

3,5 cm (1,4")



3 cm  
(1,2 inches)

### Wall bracket aluminium single

7,5 cm (3")  
10 cm (4")  
15 cm (6")

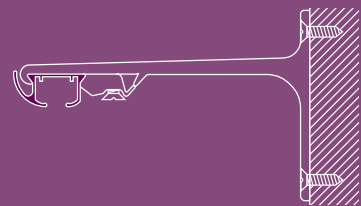

### Wall bracket aluminium double

15 cm (6")  
20 cm (8")

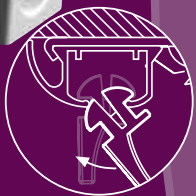
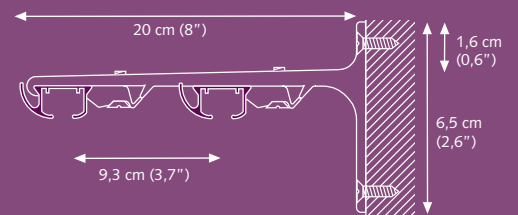

22 mm (0,9")

clickable carrier



Easy installation  
click - position - tighten

- Other brackets are available. Brackets need to be placed every 60 cm (24").

**Colours available from stock:**

Complete the art.nr. with the indicated colour-code

**01 White 03 Silver 06 Black**

Other colours can be delivered on request.

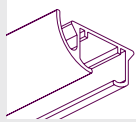
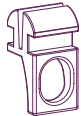
**DS Track**Aluminium extrusion, powder coated, lubricated.  
4 m (13'1"), 5 m (16'4"),  
6 m (19'8").20010..00 cm  
20/tube**Carrier**

"Klickable", offset, constructed of UV resistant plastic. 10 Carriers on a break-away strip. Can be clicked in after installation. Colours: 01, 03, 06.

10100..000  
500/box**Stop Carrier**

Prevents slide back, "klickable", constructed of UV resistant plastic. Colours: 01, 03, 06.

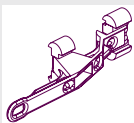
10102..000  
250/box**Master Carrier/Reversible**

Reversible overlap carrier, "Klicks" into track, constructed of UV resistant plastic. For straight track only. Colour: 01.

1010301000  
25/box**Shirrtape Carrier**

Carrier and hook in one "klickable" unit, constructed of UV resistant plastic. For sew on drapery tape.

10104..000  
500/box**Carrier with Metal Hook**

"Klickable", offset, with stainless steel hook, constructed of UV resistant plastic. For use with grommets.

10105..000  
100/box**Twist End Stop**

"Twists" into track, with metal plate, constructed of UV resistant plastic. Colours: 01, 03, 06.

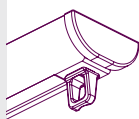
10162..000  
100/box**Twist End Stop with Cap**

"Twists" into track, with metal plate and end cap, constructed of UV resistant plastic. Colours: 01, 03, 06.

20163..000  
100/box**Easyfold DS Endcap + screw**

To be screwed with an Easyfold carrier, made of UV-resistant plastic. Colours: 01, 03, 06.

48161..000  
100/box**DS Endcap + Screw Short**

To be used for single drawn curtains. Colours: 01, 03, 06.

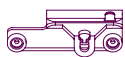
20060..000  
100/box**Carrier Underlap Left**

The Plastic Master is reversible. There are also snaps on the back of the Master. Colours: 00, 01, 03, 06.

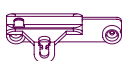
25 pcs/box  
48151..010**Carrier Overlap Right**

The Plastic Master is reversible. There are also snaps on the back of the Master. Colours: 00, 01, 03, 06.

25 pcs/box  
48152..010**Ceiling Bracket**

Slides onto the track, powder coated. Regular duty. Colours: 01, 03, 06.

10180..000  
100/box**Ceiling Bracket with Slot**

Slides onto the track, powder coated. Regular duty. Colours: 01, 03, 06.

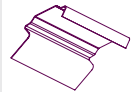
10181..000  
100/box**Klick on Splice**

For ceiling and wall installation, powder coated. Colours: 01, 03, 06.

10184..000  
50/box**Smart Klick Ceiling Bracket**

"Klicks" onto track, powder coated. Colours: 01, 03, 06. Inclusive Covercap

10182..000  
100/box

1018201001

**Covercap for Smart Klick Ceiling Bracket**

Fits on Smart Klick Wall and Ceiling bracket. Colours: 01, 03, 06.

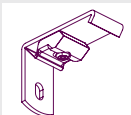
10182..001  
100/box**Smart Klick Wall Bracket**

3,5 cm (1,4") and 6 cm (2,4"). "Klicks" onto track, powder coated. One screw attachment. For light weight use only. Colours: 01, 03, 06.

50/box

10202..035

10202..060

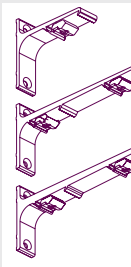
**Aluminium Wall bracket**

Smart klick, powder coated.

10203..000mm

7,5 cm single (3")

20/box

10 cm single (4")

20/box

15 cm double (6")

15/box

20 cm double (8")

15/box

25 cm triple (10")

10/box

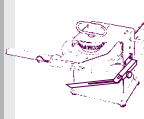
**Compact Bending House**

For DS

1050000000  
1/each**DS Bending Wheel All-in**

For DS incl. strips

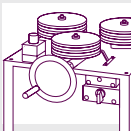
2050000000  
1/each**Electric Powered Bender**

For creating continuous curves. Minimum radius 50 cm (20").

1060500000  
1/box**Bending Wheels (set of 3)**

2060700000

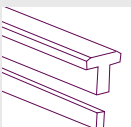
**Replacement Bending Strips**

For DS Compact Bending Tool. Length of strip: 60 cm (23"). For DS electric powered bender. Length of strip: 7 m (23').

2060100000

1/set

2060300000

1/set

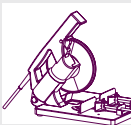
**Electric Powered Railcutter**

230 Volt EU

1061100000  
1/each**Replacement Blade**

For electric powered railcutter.

1061200000  
1/each**FOREST**  
DRAPERY HARDWARE